

NTC

Inrush Current Limiting NTC Thermistor

D-30 Series



Description

Inrush Current Limiting NTC Thermistor is a temperature sensitive resistor made of special semiconductor ceramic material with Negative Temperature Coefficient characteristics. They have a higher resistance value at room temperature. When they are energized, the temperature of the resistor body increases due to self-heating, and the resistance value decreases. Using this feature, they are used as Inrush current limiting/protection components for electrical and electronic equipment. These devices can easily and effectively limit abnormal currents, including surge currents when energized. Inrush Current Limiting NTC Thermistors used as current protection devices are also called power thermistors.

Applications

- Switch-Mode Power Supplies
- Transformers
- Inverters
- Soft-Start Motors
- LED Driver Circuit
- Halogen Lamp

Features

- Miniaturized Size
- RoHS & REACH Compliant
- -40 °C to 175 °C Operating Temperature Range
- Wide Product Diameter Range from $\Phi 5$ mm to $\Phi 30$ mm
- Silicone Sealing Material, Flame-Retardant to V0 (UL 94)



Benefits

- Fast Response
- Strong Surge Suppression Capability
- High Stable Electrical Characteristics
- The Material Constant (B value) is Large and the Residual Resistance is Small
- New Ceramic Material and Homogenization Process for a Volume-efficient, High-performance Design

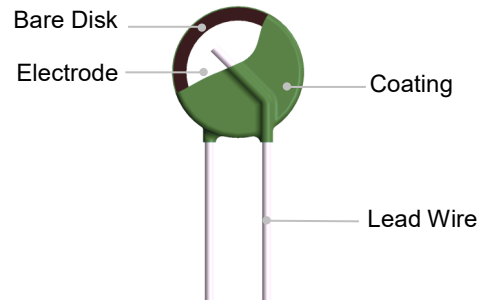
Product Structure



Agency Approvals

Agency	Standards	No.
	UL 1434	E519784
	IEC 60539-1	R 50514002
	GB/T 6663.1	CQC21001308813

Part Numbering System

SCL 5 D-30 _ M S A BN0 - 001

Other Options

Packing Mode or Lead Length

- A01: AMMO Packing (P0=12.7 mm)
- BN0: Bulk with Standard Length
- C35: Bulk with Length 3.5 mm
- L10: Bulk with Length 10 mm

Lead Type

- A: Straight Lead
- B: Inward Crimp Lead
- C: Outward Crimp Lead
- D: Inline Crimp Lead

Lead Material

- S: Tinned Copper Clad Steel Wire

R₂₅ Tolerance

- K: ± 10%
- L: ± 15%
- M: ± 20%
- N: ± 25%

Disk Diameter

- D-5: Φ5 mm D-7: Φ7 mm D-9: Φ9 mm
- D-11: Φ11 mm D-13: Φ13 mm D-15: Φ15 mm
- D-20: Φ20 mm D-25: Φ25 mm D-30: Φ30 mm

Nominal Zero-power Resistance at 25°C (R₂₅)

- 5: 5 Ω; 10: 10 Ω; 100: 100 Ω...

Product Category

Inrush Current Limiting NTC Thermistor

NTC

NTC

NTC

Inrush Current Limiting NTC Thermistor

D-30 Series

Marking

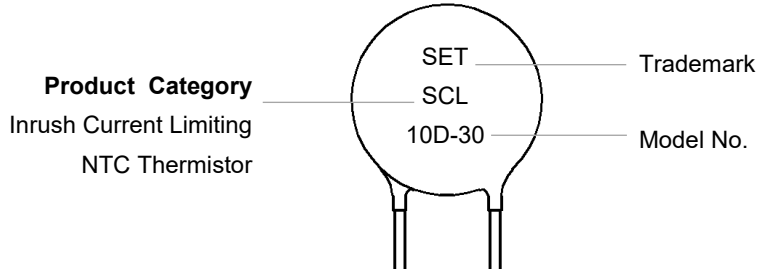

Dimensions (mm)

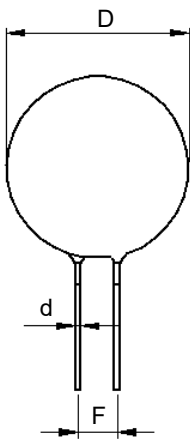

Inline Crimp Lead

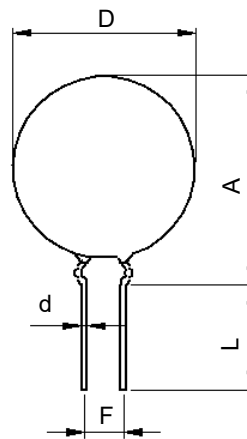
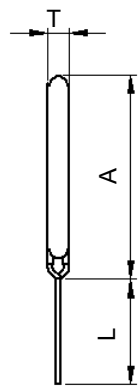

Outward Crimp Lead

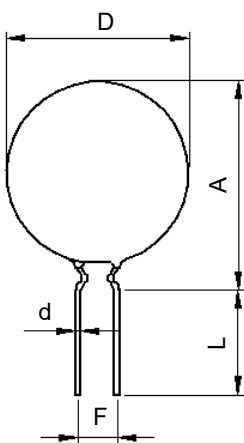
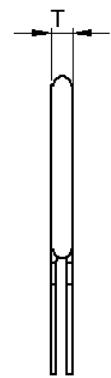

Inward Crimp Lead

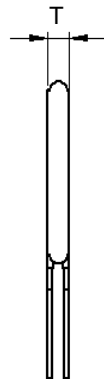

D Max.	F ± 1.0	d ± 0.05	A Max.	L Min.	T Max.
35.0	7.5	Φ1.0	40.0	20.0	10.0

Note: Alternative lead configurations available on request.

Glossary

Item	Description
R_{25}	<p>Nominal Zero Power Resistance at 25 °C Nominal value of zero-power resistance at the standard reference temperature of 25 °C, unless otherwise specified. — (IEC 60539)</p>
I_{max25}	<p>Maximum Current at 25 °C Maximum value of current (d.c. or r.m.s. values for Sine wave shaped a.c.) which can be continuously applied to the thermistor at an ambient temperature of 25 °C. — (IEC 60539)</p>
B	<p>B value Index of thermal sensitivity expressed by the formula $B = \frac{T_a \times T_b}{T_b - T_a} \times \ln \frac{R_a}{R_b}$ R_a is the zero-power resistance (Ω) at temperature T_a (k) R_b is the zero-power resistance (Ω) at temperature T_b (k) $T_a = 298.15$ K, $T_b = 358.15$ K — (IEC 60539)</p>
δ	<p>Dissipation Factor Power dissipation required for a thermistor to raise its temperature by 1 K and which is generally the ratio of the power dissipation change to the resulting thermistor body temperature change at a specified ambient temperature. — (IEC 60539)</p>
T_a	<p>Thermal Time Constant Time required for a thermistor to respond to 63.2 % of an external step change in ambient temperature in a defined medium. — (IEC 60539)</p>
$R_{min@I_{max25}}$	<p>Residual Resistance Inrush Current-limiting Thermistors value of the d.c. resistance of a thermistor when its thermal stability is reached with the maximum current passing. — (IEC 60539)</p>
C_{max}	<p>Maximum Permissible Capacitance Maximum permissible capacitance value of a capacitor which can be connected to a thermistor under loading. — (IEC 60539)</p>
P_{max25}	<p>Maximum Power Dissipation Maximum value of the power dissipation which can be continuously applied to the thermistor at 25 °C. — (IEC 60539)</p>

NTC

NTC

Electrical Specifications

Model	R_{25}	I_{max25}	$B_{25/85}$	δ	τ_a	$R_{min}@I_{max25}$	C_{max}		P_{max}	Operating Temperature Range
	(Ω)	(A)	(K)	(mW/K)	(s)	(Ω)	@120Va (μ F)	@240Vac (μ F)	(W)	($^{\circ}$ C)
SCL0.2D-30	0.2	30.0	2700	≥ 50	≤ 200	0.01	14000	3500	10.0	-40 ~ 175
SCL0.3D-30	0.3	30.0	2800	≥ 50	≤ 200	0.01	14000	3500	10.0	-40 ~ 175
SCL0.5D-30	0.5	30.0	2900	≥ 50	≤ 200	0.01	14000	3500	10.0	-40 ~ 175
SCL0.7D-30	0.7	30.0	2900	≥ 50	≤ 200	0.01	14000	3500	10.0	-40 ~ 175
SCL1D-30	1	30.0	2965	≥ 50	≤ 200	0.01	14000	3500	10.0	-40 ~ 175
SCL1.3D-30	1.3	26.0	2965	≥ 50	≤ 200	0.01	14000	3500	10.0	-40 ~ 175
SCL1.5D-30	1.5	25.0	3065	≥ 50	≤ 200	0.01	14000	3500	10.0	-40 ~ 175
SCL2D-30	2	23.0	3065	≥ 50	≤ 200	0.02	14000	3500	10.0	-40 ~ 175
SCL2.2D-30	2.2	20.0	3065	≥ 50	≤ 200	0.02	14000	3500	10.0	-40 ~ 175
SCL2.5D-30	2.5	18.0	3165	≥ 50	≤ 200	0.02	14000	3500	10.0	-40 ~ 175
SCL3D-30	3	17.0	3165	≥ 50	≤ 200	0.03	14000	3500	10.0	-40 ~ 175
SCL4D-30	4	16.0	3265	≥ 50	≤ 200	0.03	14000	3500	10.0	-40 ~ 175
SCL4.7D-30	4.7	15.0	3265	≥ 50	≤ 200	0.03	14000	3500	10.0	-40 ~ 175
SCL5D-30	5	14.0	3265	≥ 50	≤ 200	0.04	14000	3500	10.0	-40 ~ 175
SCL6D-30	6	13.0	3265	≥ 50	≤ 200	0.04	14000	3500	10.0	-40 ~ 175
SCL6.8D-30	6.8	12.0	3450	≥ 50	≤ 200	0.05	14000	3500	10.0	-40 ~ 175
SCL7D-30	7	11.5	3450	≥ 50	≤ 200	0.05	14000	3500	10.0	-40 ~ 175
SCL8D-30	8	10.5	3450	≥ 50	≤ 200	0.06	14000	3500	10.0	-40 ~ 175
SCL10D-30	10	10.0	3450	≥ 50	≤ 200	0.07	14000	3500	10.0	-40 ~ 175
SCL12D-30	12	9.0	3450	≥ 50	≤ 200	0.08	14000	3500	10.0	-40 ~ 175
SCL13D-30	13	8.5	3560	≥ 50	≤ 200	0.09	14000	3500	10.0	-40 ~ 175
SCL15D-30	15	8.0	3560	≥ 50	≤ 200	0.10	14000	3500	10.0	-40 ~ 175
SCL16D-30	16	7.5	3620	≥ 50	≤ 200	0.12	14000	3500	10.0	-40 ~ 175
SCL18D-30	18	7.0	3620	≥ 50	≤ 200	0.13	14000	3500	10.0	-40 ~ 175
SCL20D-30	20	6.0	3620	≥ 50	≤ 200	0.17	14000	3500	10.0	-40 ~ 175
SCL25D-30	25	6.0	3620	≥ 50	≤ 200	0.18	14000	3500	10.0	-40 ~ 175
SCL30D-30	30	5.5	3620	≥ 50	≤ 200	0.21	14000	3500	10.0	-40 ~ 175
SCL33D-30	33	5.0	3620	≥ 50	≤ 200	0.24	14000	3500	10.0	-40 ~ 175

NTC

NTC

NTC

Inrush Current Limiting NTC Thermistor

D-30 Series

Max. Current Derating Curve

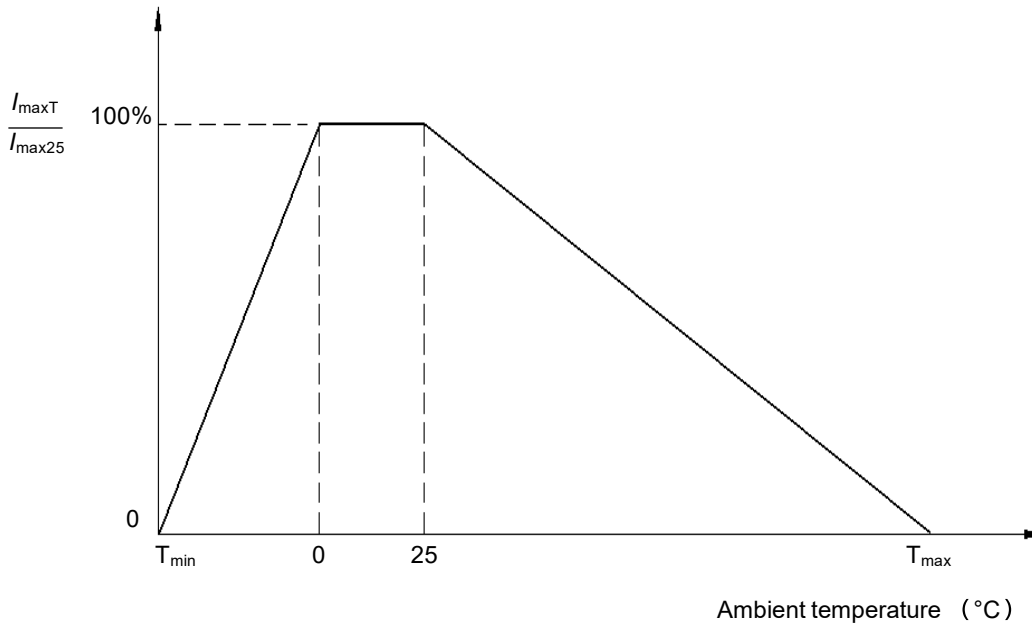

T_{max} : Maximum Operating Temperature (°C)

T_{min} : Minimum Operating Temperature (°C)

$$T_{min} < T < 0: I_{maxT} = \left[1 - \frac{0-T}{0-T_{min}} \right] \times I_{max25}$$

$$25 < T < T_{max}: I_{maxT} = \left[1 - \frac{T-25}{T_{max}-25} \right] \times I_{max25}$$

For Example:

T_{min} : -40 °C T_{max} : 175 °C

Ambient Temperature (T) = -10 °C

$$\begin{aligned} I_{maxT} &= \left[1 - \frac{0-T}{0-T_{min}} \right] \times I_{max25} \\ &= 75\% I_{max25} \end{aligned}$$

Ambient Temperature (T) = 60 °C

$$\begin{aligned} I_{maxT} &= \left[1 - \frac{T-25}{T_{max}-25} \right] \times I_{max25} \\ &= 77\% I_{max25} \end{aligned}$$

NTC

Inrush Current Limiting NTC Thermistor

D-30 Series

R-T Characteristic Curves (Reference)

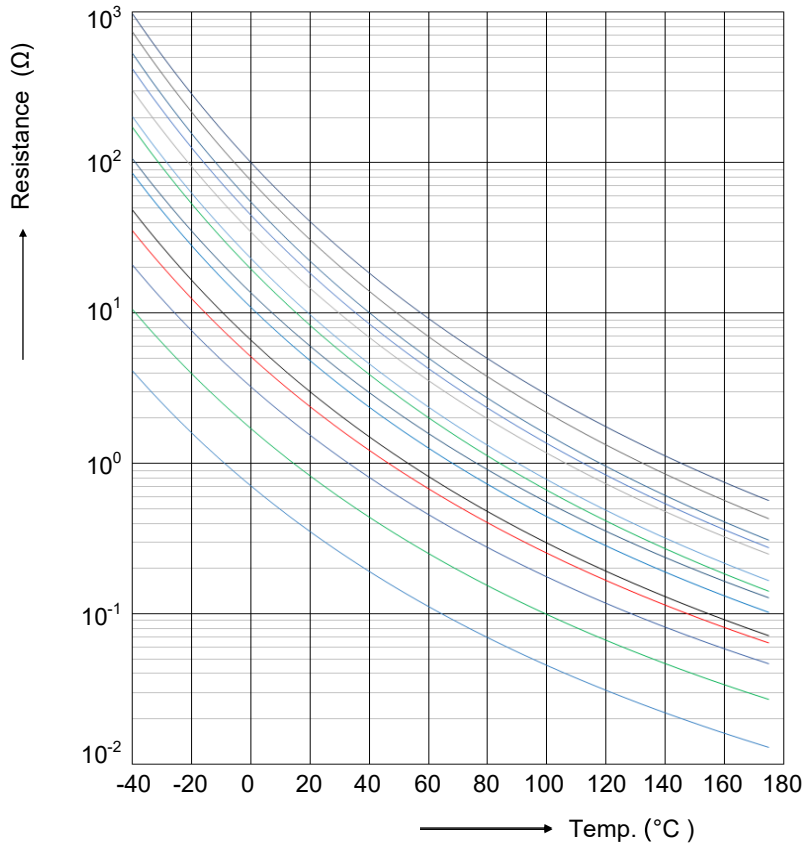

- 33D-30
- 25D-30
- 18D-30
- 15D-30
- 12D-30
- 8D-30
- 6.8D-30
- 5D-30
- 4D-30
- 2.5D-30
- 2D-30
- 1.3D-30
- 0.7D-30
- 0.3D-30

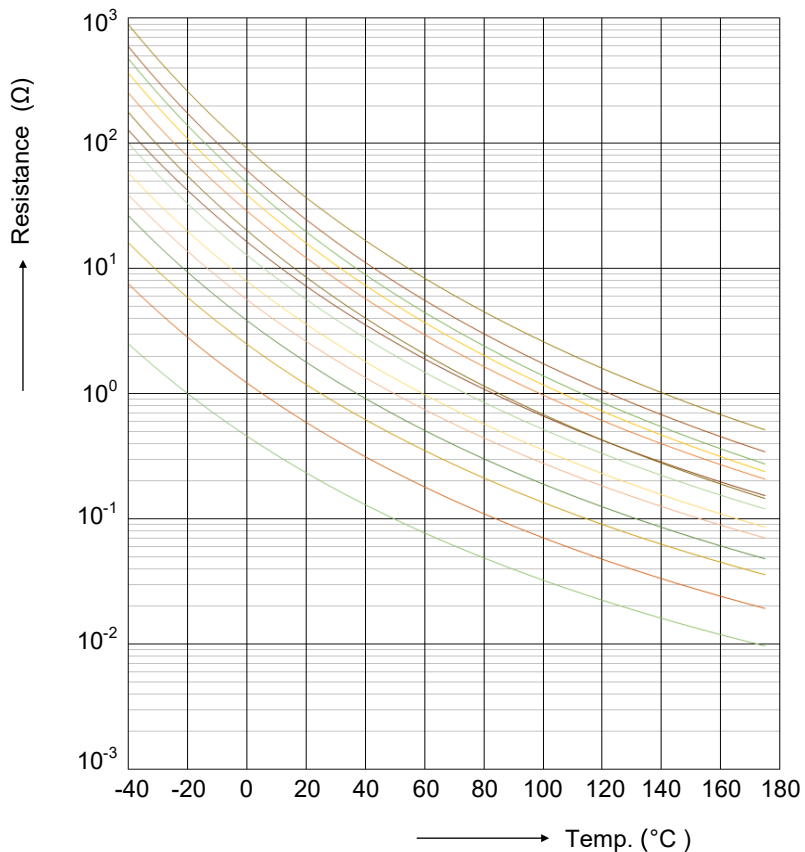

- 30D-30
- 20D-30
- 16D-30
- 13D-30
- 10D-30
- 7D-30
- 6D-30
- 4.7D-30
- 3D-30
- 2.2D-30
- 1.5D-30
- 1D-30
- 0.5D-30
- 0.2D-30

NTC

NTC

NTC

Inrush Current Limiting NTC Thermistor

D-30 Series

Resistance & Current Curves (Reference)

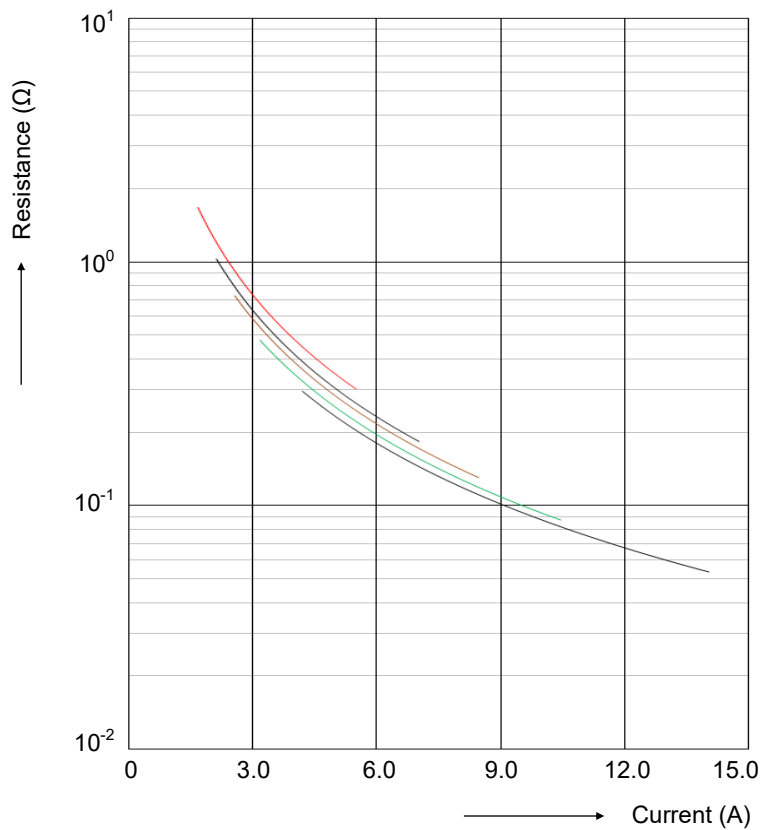
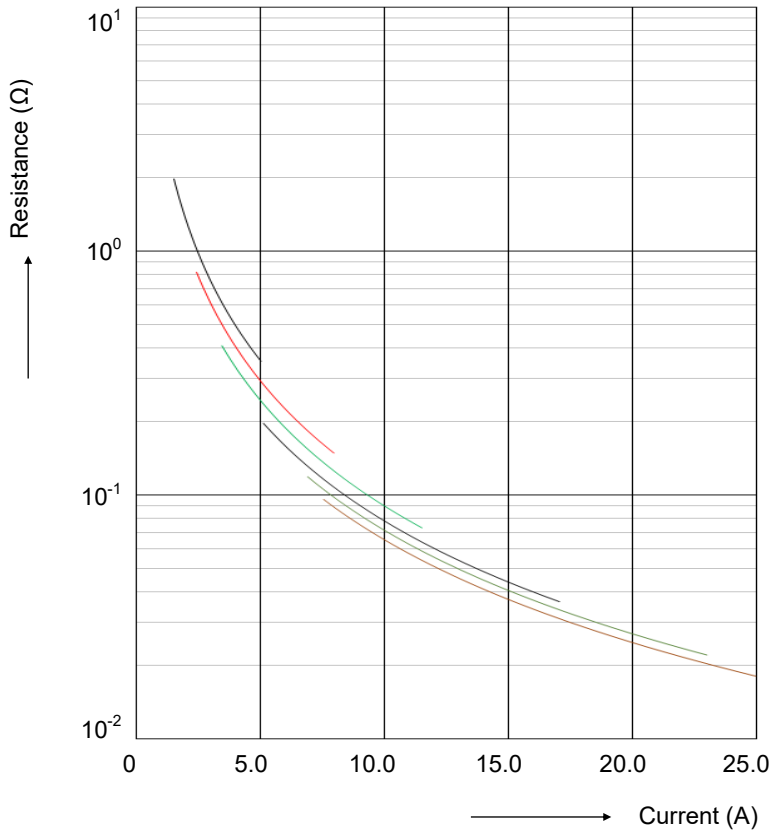

NTC

NTC

NTC

Inrush Current Limiting NTC Thermistor

D-30 Series

Resistance & Current Curves (Reference)

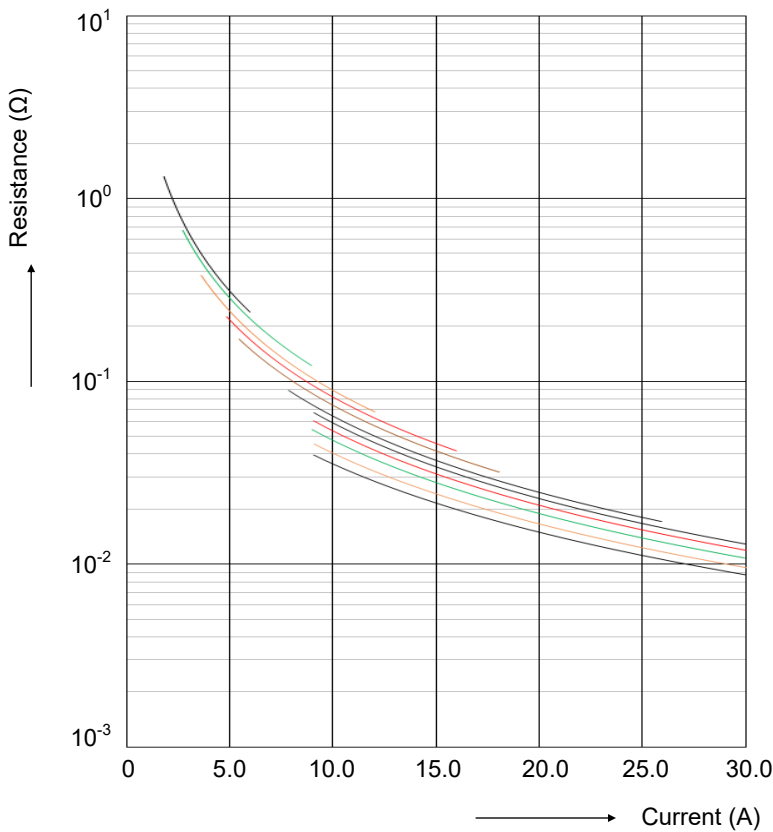
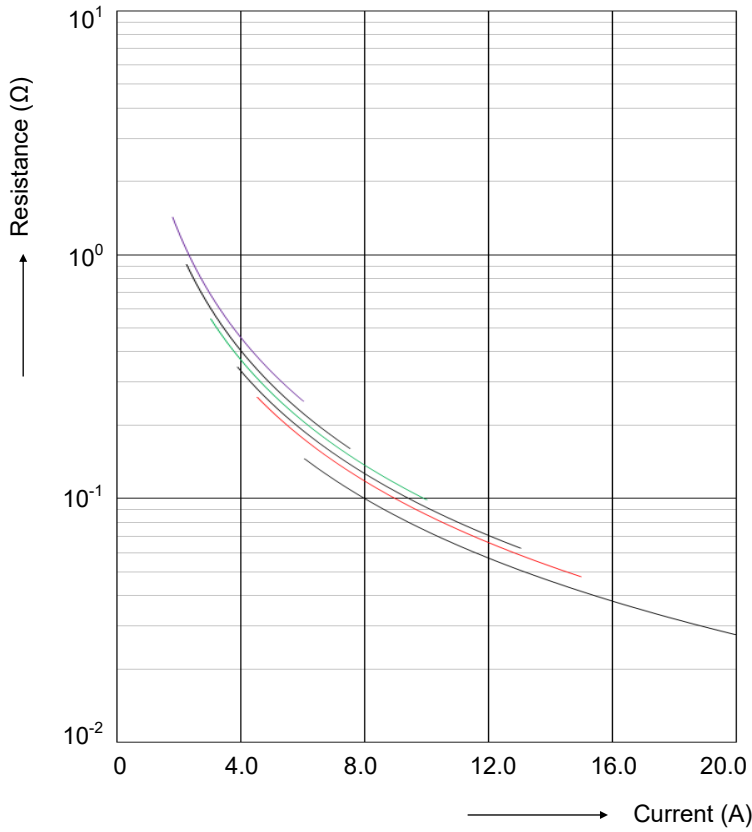

NTC

NTC

Soldering Parameters

1. Wave Soldering Parameters

The wave soldering parameters are for reference only. When NTC is for practice use, some related validation is recommended.

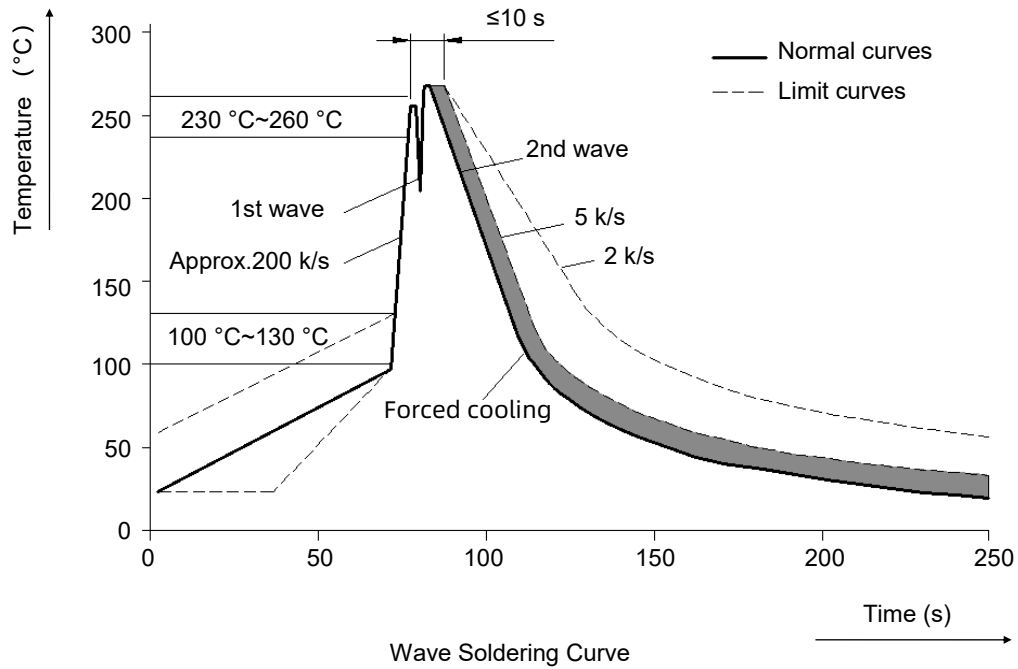

2. Recommended Hand-Solder Parameters

For hand soldering, please notice the solder tip temperature and the soldering time, recommended as follows:

Items	Conditions
Temp. of Solder Head	360 °C (max.)
Soldering Time	3 seconds (max.)
Distance from Thermistor	2 mm (min.)

Packaging

1. Bulk Packaging (Code: BN0)

Item	PE Bag	Inner Box	Carton
Dimensions (mm)	200 × 210	245 × 165 × 67	365 × 265 × 245
Quantity (PCS)	50	100	600

Notes: Packaging dimensions and quantity are for reference only.

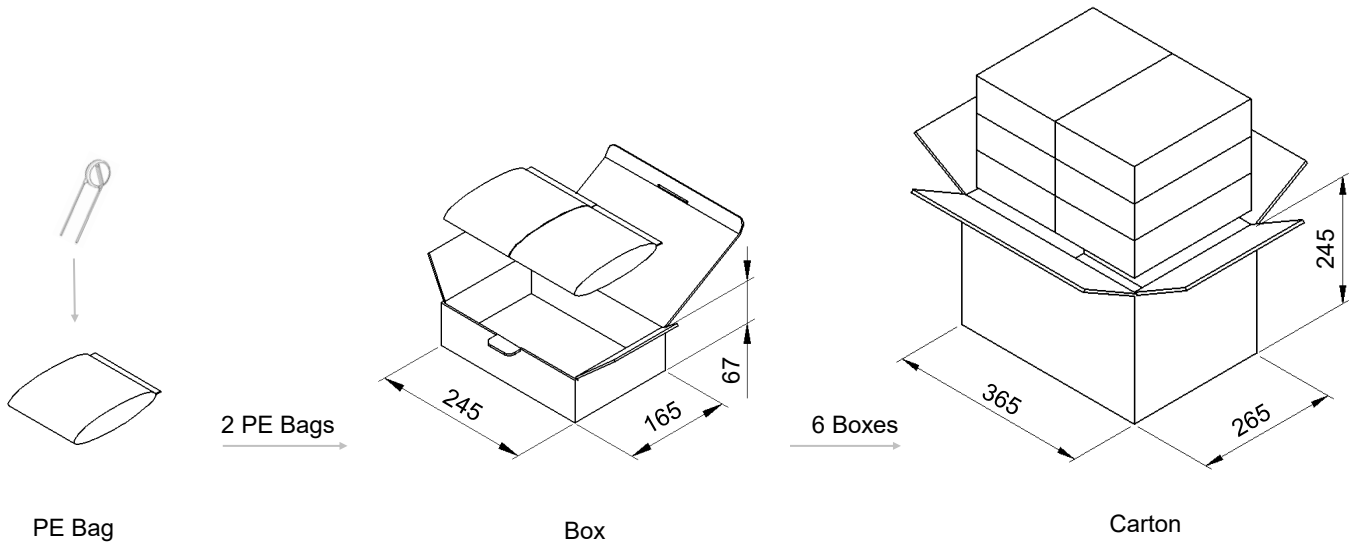



ATTENTION

Usage

1. Thermistor must be operated within the specified ambient temperature.
2. Do not clean the thermistor with strong polar solvent such as ketone, esters, benzene, halogenated hydrocarbon, to avoid damaging the encapsulating layer.
1. Please do not apply severe vibration, shock or pressure to thermistor, to avoid surface resin or element cracking.
2. Please fix lead wires when bending or cutting. the distance between the bending point and the sealing of thermistor shall be greater than 2 mm.

Replacement

1. If thermistor is visually damaged, please replace it.
2. Thermistor is a non-repairable product. for safety sake, please use equivalent thermistor for replacement

Storage

1. Storage thermistor only in original packaging. do not open the package before storage.
2. Storage temperature range: -25 to 45 °C.
3. Relative humidity : $\leq 75\%$ RH.
4. Keep away from corrosive gas and direct sunlight.
5. Period of storage: ≤ 1 Year.

Installation

Do not take violent action such as knocking when assembling to avoid mechanical damage.